

User Manual of DAR-5001A/B/C & DAR-5002C Standalone Voice Logger

Directory

Chapter One	DAR5001A/B/C Manual	2
1.1	Features	2
1.2	Installation Methods.....	3
1.3	Functional description of each ministry	4
1.4	LCD Screen Display Instructions.....	5
1.5	Settings List	6
Chapter Two	Setting Function	7
2.1	Date and Time Setting.....	7
2.2	Volume setting.....	8
2.3	LCD Contrast setting	8
2.4	Setting of voltage threshold.....	9
2.5	Recording Trigger Settings.....	9
2.6	Shortest Recording Setting.....	10
2.7	Longest Recording Setting	10
2.8	Voice Announcement setting.....	11
2.9	Voice announcement to speaker setting	12
2.10	Message Ring Count Setting	12
2.11	Maximum Message Time Setting	13
2.12	Voice control sensitivity setting.....	13
2.13	FSK Correction Time Setting	14
Chapter Third	Playback of recorded files.....	14
Chapter Four	Upgrades and other considerations	15
Chapter Five	OGM/anti-harassment.....	17

Chapter One DAR5001A/B/C Manual

1.1 Features

- ◆ Use SD card to store messages/recordings
- ◆ Incoming call message/extension call recording
- ◆ Support voltage control/voice control recording mode
- ◆ Support up to 128G memory card (**Format: FAT32**)
- ◆ Dual system caller ID (FSK/DTMF)
- ◆ Message and voice announcement audio files can be modified by the user
- ◆ Voice announcement for incoming calls to prevent harassing the phone and send CID to extension (only A series supports this function)
- ◆ LCD screen brightness 5 levels adjustable
- ◆ Built-in clock display, unchanged power-down time, can realize FSK automatic time calibration
- ◆ Playback by time index (display CID and date)
- ◆ Built-in speaker, the sound can be played immediately
- ◆ Recording files can be transferred to PC for storage and playback
- ◆ Computer-free automatic recording, completely embedded device

SD Recording time

- 16GB Recording time 590 hour
- 32GB Recording time 1180 hour
- 64GB Recording time 2360 hour
- 128G Recording time 4720 hour

Important statement

This product strictly prohibits the secret recording without the permission of others. If you violate the law, you must bear your own legal responsibility.

Function/Model	DAR5001A	DAR5001B	DAR5001C	DAR5002C
Channel	1CH	1CH	1CH	2CH
Voice announcement	Yes	NO	NO	NO
Incoming call anti-harassment function	Yes	NO	NO	NO
Auto answer	Yes	Yes	NO	NO
Caller ID	Yes	Yes	NO	NO
Local playback	Yes	Yes	Yes	Yes
Automatic recording	Yes	Yes	Yes	Yes
Recording mode (voltage control or sound control)	Yes	Yes	Yes	Yes

Speaker	Yes	Yes	Yes	Yes
SD card storage	Yes	Yes	Yes	Yes
FSK automatic time adjustment	Yes	Yes	NO	NO
screen display	Yes	Yes	Yes	Yes
Comes with clock	Yes	Yes	Yes	Yes

Note: All of our products support customization (can be customized according to customer Requirements, starting from 3K

1.2 Installation Methods

(Must read when using this product for the first time)

- 1、 Connect the telephone line to the RJ11 port on the right side of the recording box. (Picture 1)
- 2、 Insert SD card (Picture 2)
- 3、 Plug the telephone line provided by the telecommunications company into the RJ11 port on the left side of the recording box. (Picture 3)
- 4、 Connect the power adapter to the DC power adapter jack on the bottom of the recording box (Picture4)

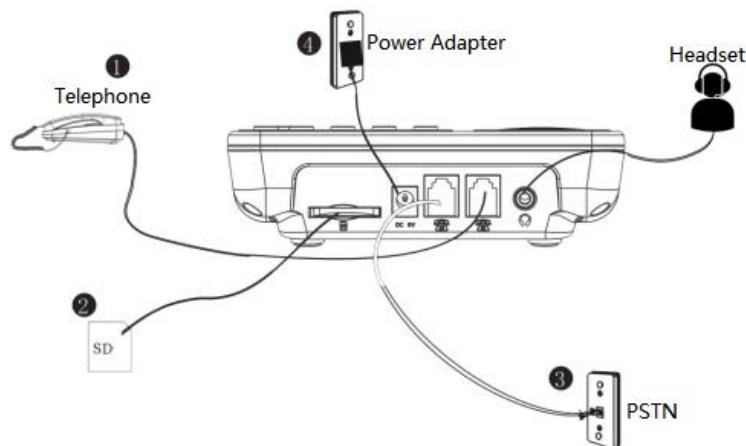

This unit can't use any recording and other functions when there is no SD card. Please don't remove the SD card at will.

After the machine is plugged in, if you want to use the answering function, please set the number of rings first. For example, set the number of rings to 3 and start the answering function. If no one answers the call within 3 rings, it will automatically enter the answering mode. Use the built-in host message! (If the call is answered within the set number of rings, the answering machine will not enter the answering mode).

When the number of rings is set to [00], the answering function is turned off.

When the number of rings is set to [2-9], the answering machine function is activated.

Please follow the steps below before use

1. Please make a voice announcement file before use
2. Install SD card, insert power, LCD display  After the card is read, the screen will display the remaining space of the SD card.
3. Set the number of rings for answering: answer on/off.
4. Set the time / date.

1.3 Functional description of each ministry

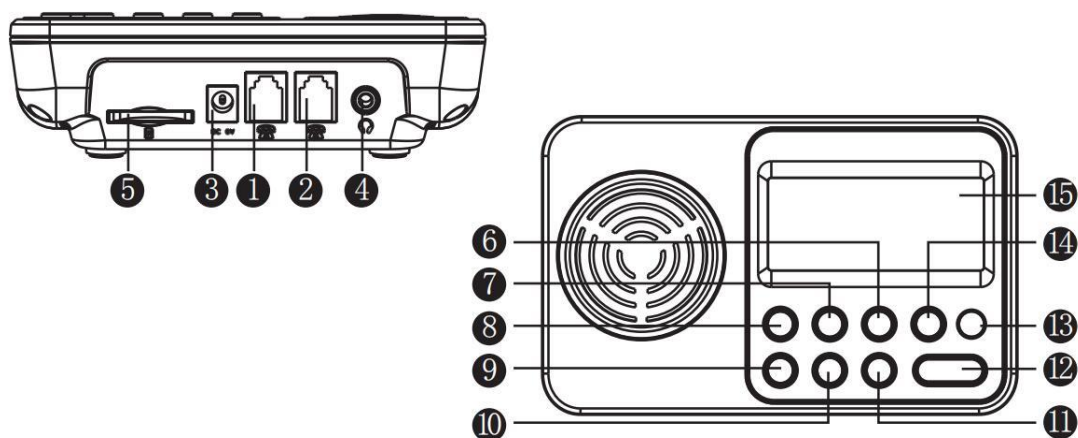

1	PSTN interface	connection telephone station
2	Extension socket	Extension telephone line (5002C:connection telephone station)
3	Power Jack	Connect the power adapter
4	Headphone Jack	Connect headphones
5	SD card slot	Insert SD memory card
6	Delete key	Delete the current recording during playback
7	Up	Up buttons
8	Setup	Enter setup options
9	Left	Left buttons
10	Down	Down buttons
11	Right	Right buttons
12	Confirm	Confirm/playback

13	LED	Signal indicator
14	Return	Back/Cancel
15	Display Screen	Display Information Content

1.4 LCD Screen Display Instructions

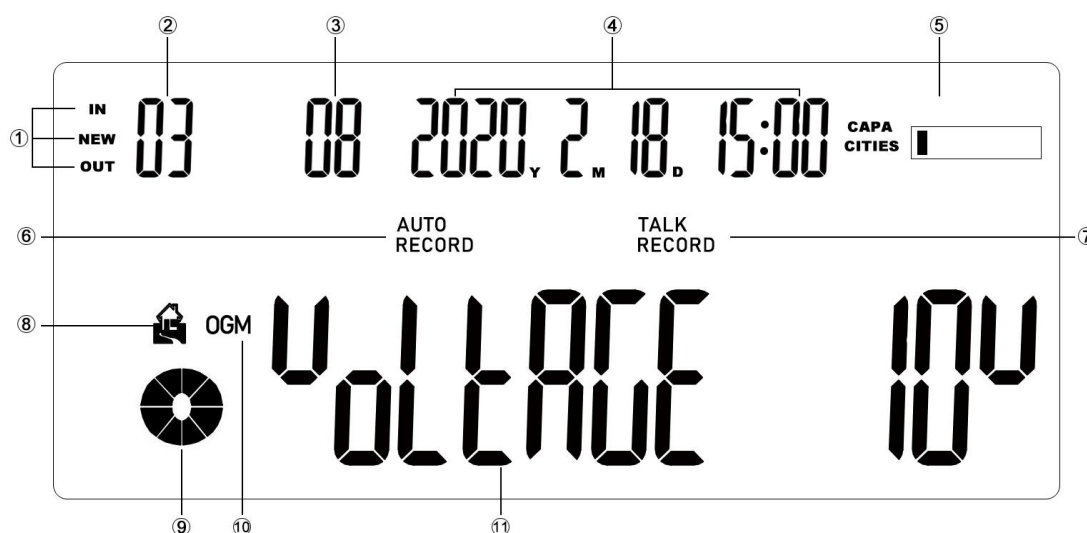

1	Recording type (playback)	IN: Incoming Telegram Recording
		NEW: Message Recording
		OUT: Outing Calls Recording
		Vacancy: Voice-activated Recording
2	Current serial number	Playback: the serial number of the current file
3	Total recordings for the day	Recording: display recording duration
		Playback: Displays the total number of recordings on the day of playback
4	Time/Date Display	Home:screen:show current time/date
		Playback:Display the current Time/Date of Playback
5	SD Card space	Display memory space
6	Automatic Recording Icon	This icon lights up when recording is turned on
7	Recording Icon	Light up this icon during recording, and the LED will flash at the same time
8	Message Icon	Lights up when the message function is turned on
9	Play progress bar	Show playback progress during playback
10	OGM Icon	Light this icon when voice announcement is turned on

		(version A only)
11	Break code display	Software function display area

1.5 Settings List

All settings must be operated on the home screen

Display	Function Description	Operation Method	Default
DATE	Date/time setting	Setup+Confirm	
VOLUME	Volume setting	Setup+1 times turn Down+Confirm	2
LCD LIGHT	LCD Contrast setting	Setup+2 times turn Down+Confirm	4
OFFHOOK VOLT	Voltage threshold setting	Setup+3 times turn Down+Confirm	10
REC TRIGGER	Start recording condition setting	Setup+4 times turn Down+Confirm	Voltage Trigger
MIN TIME	Minimum recording time setting	Setup+5 times turn Down+Confirm	1
MAX TIME	Maximum recording time setting	Setup+6 times turn Down+Confirm	120
ANN	Voice announcement setting (not for C type)	Setup+7 times turn Down+Confirm (Only for Voltage Trigger)	OFF
ANN SPE	Voice announcement to speaker	Setup+8 times turn Down+Confirm	OFF
MSG RING	Message ringing times setting	Setup+9 times turn Down+Confirm (Only for Voltage Trigger)	0
MSG MAX	Maximum message time setting	Setup+ 10 times turn Down + Confirm	15
Voice CE	Voice control sensitivity setting	Setup + 11 times turn Down + Confirm	5
FSK TIME	FSK Correction time setting	Setup + 12 times turn Down + Confirm	OFF

*Press the **back key** to exit the setting*

SD memory card precautions

1. In order to bring out the best performance of this machine, please insert the (DC 8V 500mA) power adapter and SD card configured in this machine in the correct direction (the SD card must be in the unlocked position) before using the phone line.
2. When the power adapter and SD card are installed, the unit automatically reads the SD

card and the LCD screen displays. After the card is read, the screen displays the total SD space and used space.

3. This unit cannot be used without a power adapter connected or power failure.
4. When there is no SD card, this unit cannot use functions such as recording and playback.
5. This machine supports SD card with **FAT32 format**. If the new card cannot be used, please format to FAT32 format on the computer.
6. When the machine works abnormally, please unplug the power supply and external line, and then connect the power supply and external line to test the device after one minute.
7. This unit is on a 1GB SD card and the recording time is about 34 hours. (This machine supports a maximum of 128GB SD card and records up to 199 recording files per day)

All configuration files are saved in SD Card with file named "Setting" in the root directory of SD Card. If the SD card is replaced, the configuration file will be lost and the device will come back to factory mode.

Chapter Two Setting Function

2.1 Date and Time Setting

1. On the home screen, press the **Settings** key to display **DATE**. Then press the **Confirmation** key, the screen displays:



2. Press: Up/Down/Left/Right Key Adjust Year/Month/Day/Hour/Minute
3. After the adjustment is completed, press the confirmation key to complete the setting

Note:

※The telecommunications sent by the telecommunications bureau has two systems, FSK and DTMF. If the FSK automatic time calibration function is enabled, the time will be automatically updated when receiving FSK incoming call information. If it is a DTMF

system, you must set the time yourself.

2.2 Volume setting

1. When in the home screen, press the **Setting** key + 1 times turn **Down** to display **VOLUME**. Then press the **Confirmation** key, the screen displays:

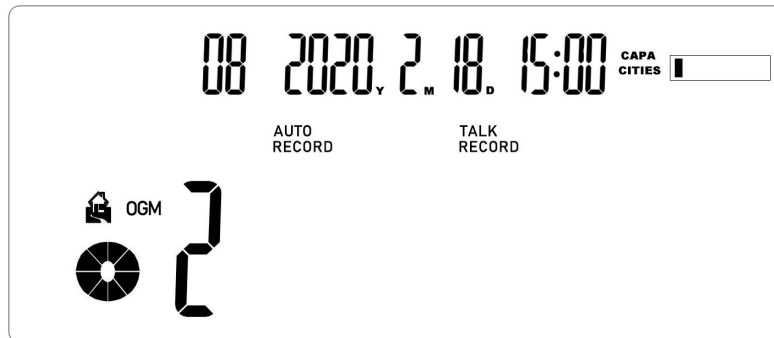

2. Press the up/down keys to adjust the volume in order, divided into 1,2,3 levels (will play sound test volume)
3. After the adjustment is completed, press the confirmation key to complete the setting

2.3 LCD Contrast setting

1. When in the home screen, press the **Setting** key + 2 times turn **Down** to display **LCD CONTRAST**. Then press the **Confirmation** key, the screen displays:

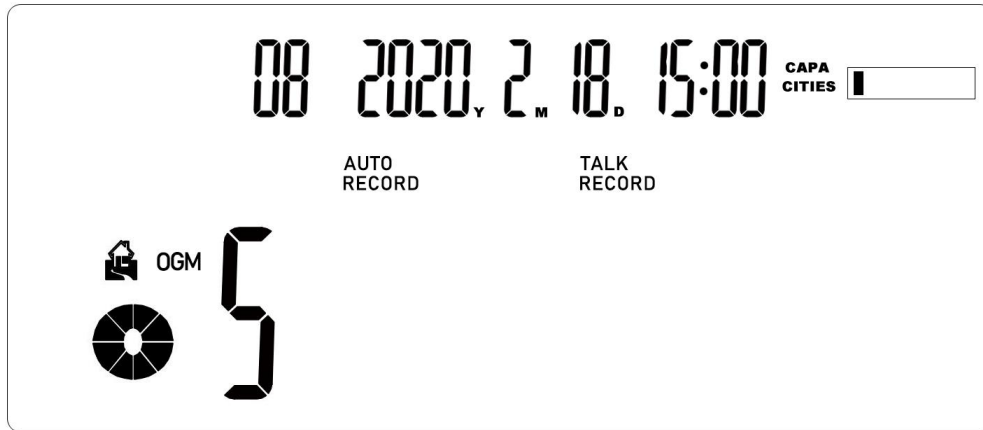

2. Press the up/down keys to adjust the screen brightness in order, divided into 1, 2, 3, 4, 5 levels (the larger the value, the higher the brightness)
3. After the adjustment is completed, press the confirmation key to complete the setting

2.4 Setting of voltage threshold

1. When in the home screen, press the **Setting** key + 3 times turn **Down** to display **OFFHOOK VOLT**. Then press the **Confirmation** key, the screen displays:

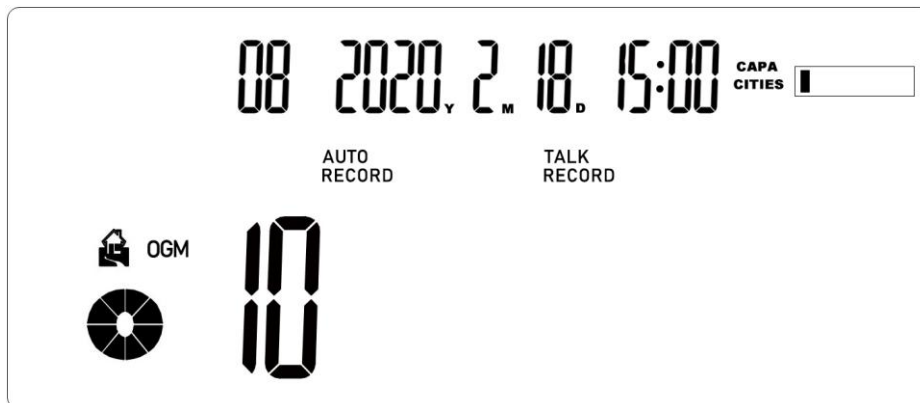

2. Press up/down/left/right to adjust the voltage threshold sequentially (factory default 10V)
3. After the adjustment is completed, press the confirmation key to complete the setting

2.5 Recording Trigger Settings

1. When in the home screen, press the **Setting** key + 4 times turn **Down** to display **REC TRIGG**. Then press the **Confirmation** key, the screen displays:



2. Press the up/down keys to adjust the start recording conditions in sequence (three conditions in total)

VOLTAGE	Voltage controlled
VOICE	Voice controlled
no rEC	Not Recording

3. After the adjustment is completed, press the confirmation key to complete the setting

2.6 Shortest Recording Setting

1. When in the home screen, press the **Setting** key + 5 times turn **Down** to display **01**. Then press the **Confirmation** key, the screen displays:

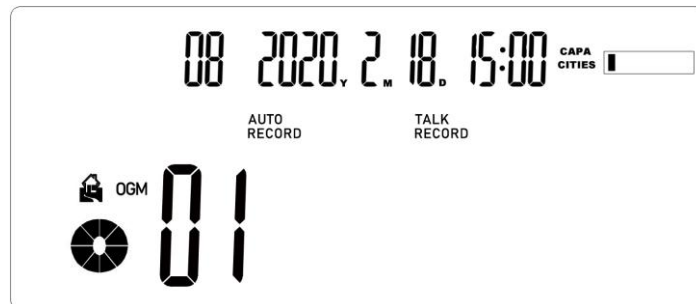

2. Press Up/Down/Left/Right to set the minimum recording duration (1-20 seconds)

3. After the adjustment is completed, press the confirmation key to complete the setting

2.7 Longest Recording Setting

1. When in the home screen, press the **Setting** key + 6 times turn **Down** to display **01**. Then press the **Confirmation** key, the screen displays:

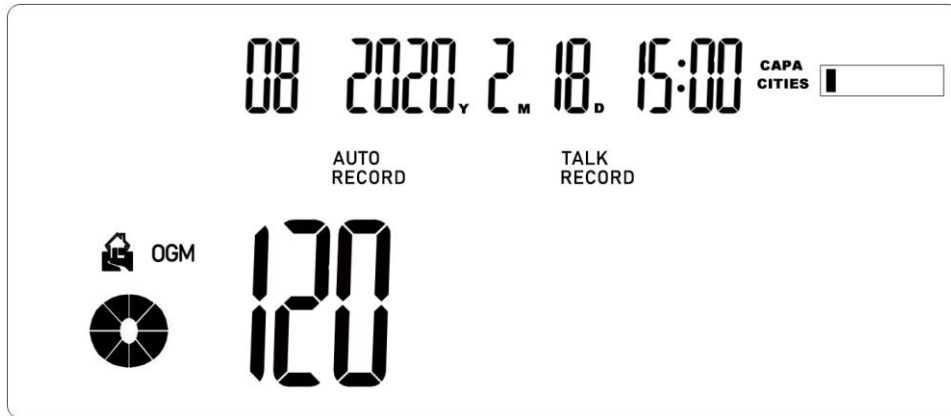

2. Press Up/Down/Left/Right to set the longest recording duration in sequence (1-120 minutes)
3. After the adjustment is completed, press the confirmation key to complete the setting

2.8 Voice Announcement setting

Note: Only A series supports voice announcement function

1. When in the home screen, press the **Setting** key + 7 times turn **Down** to display . Then press the **Confirmation** key, the screen displays:

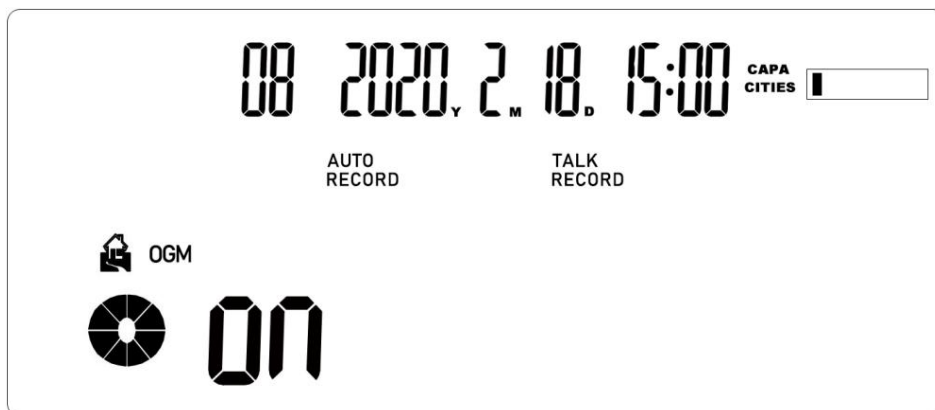

2. Press the Up/Down button to set the voice announcement function on / off (when the voice announcement is on, the OGM word on the home screen will be lit), ON means open, OFF means close

OGM only be available with "Voltage Trigger" method, and not for "Voice/Audio

Trigger” method.

After the adjustment is completed, press the confirmation key to complete the setting

2.9 Voice announcement to speaker setting

1. When in the home screen, press the **Setting** key + 8 times turn **Down** to display

08 2020.2.18. 15:00. Then press the **Confirmation** key, the screen displays:

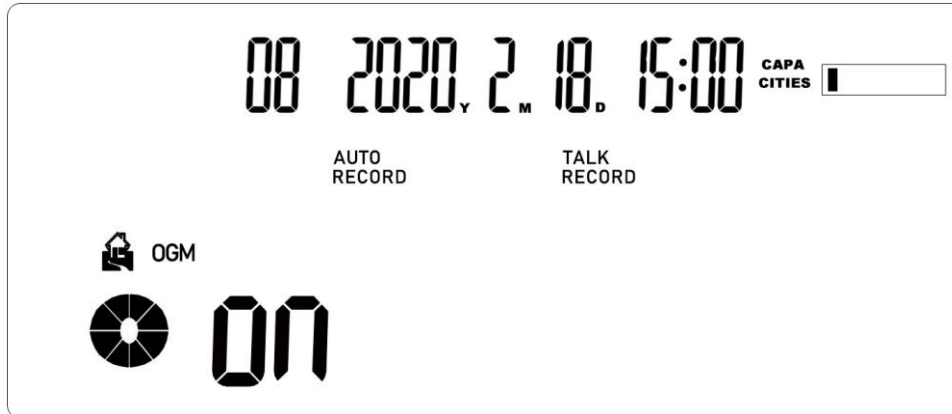

2. Press the Up/Down button to set Voice announcement to speaker

3. After the adjustment is completed, press the confirmation key to complete the setting

2.10 Message Ring Count Setting

1. When in the home screen, press the **Setting** key + 9 times turn **Down** to display:

08 2020.2.18. 15:00. Then press the **Confirmation** key, the screen displays:

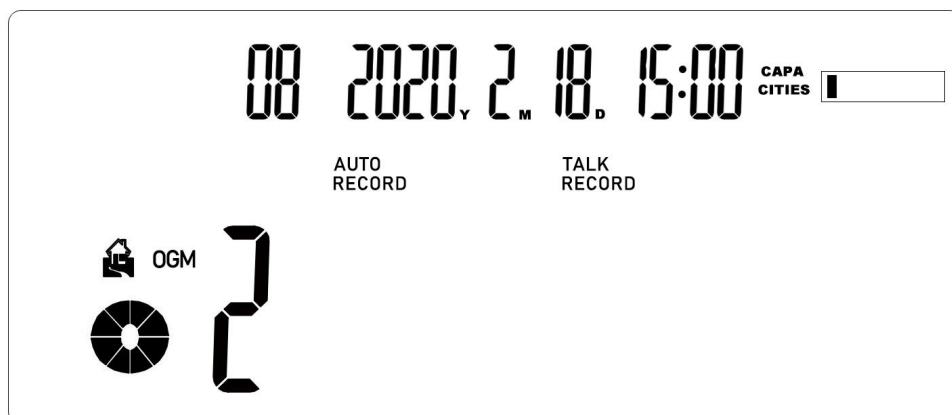

2. Press the Up/Down keys to set the number of ringing times for the message (0 means turn off the message function, 2-9 means ring times when the message function is on)

- After the adjustment is completed, press the confirmation key to complete the setting

2.11 Maximum Message Time Setting

- When in the home screen, press the **Setting** key + 10 times turn **Down** to display **הגדרת זמן הודעה**. Then press the **Confirmation** key, the screen displays:

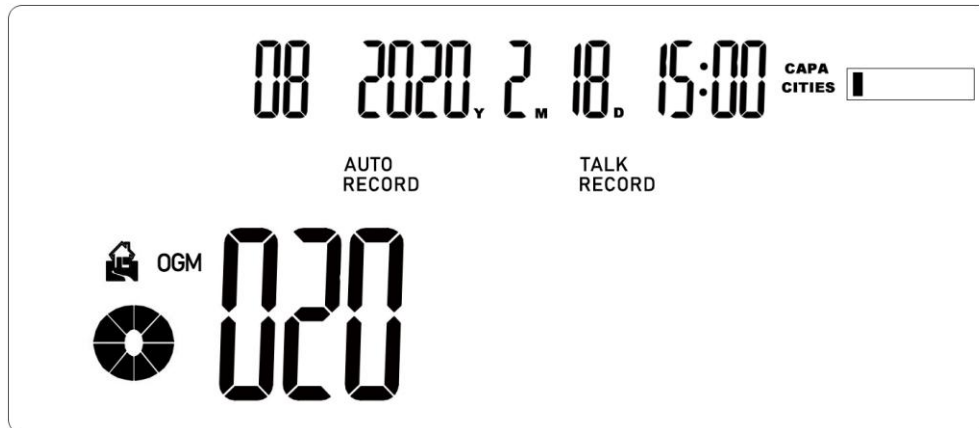

- Press Up/Down/Left/Right to set the maximum message time (5-120 seconds)
Note: When the message time reaches the set value, the device will auto close the message.
- After the adjustment is completed, press the confirmation key to complete the setting

2.12 Voice control sensitivity setting

- When in the home screen, press the **Setting** key + 11 times turn **Down** to display **הגדרת רגישות**. Then press the **Confirmation** key, the screen displays:

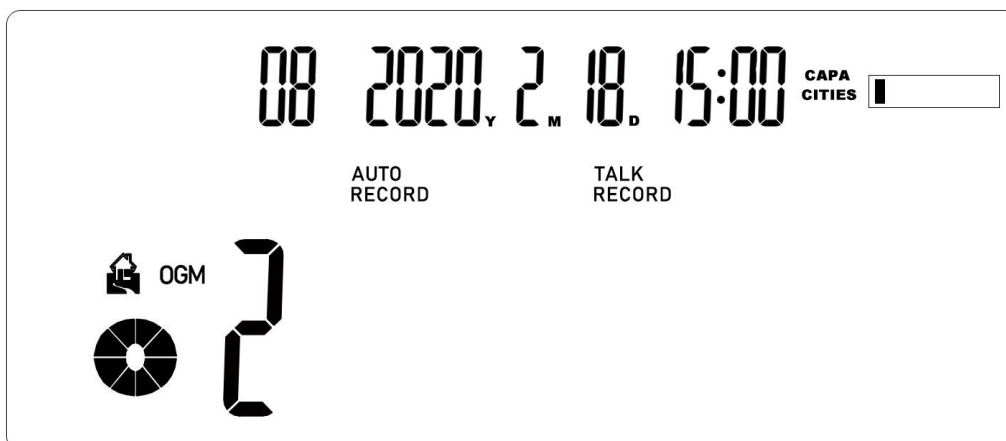

- Press Up/Down keys to set the voice sensitivity, a total of 1-9 levels (the larger the value, the higher the sensitivity)

3. After the adjustment is completed, press the confirmation key to complete the setting

2.13 FSK Correction Time Setting

1. When in the home screen, press the **Setting** key + 12 times turn **Down** to display **FSK TIME**. Then press the **Confirmation** key, the screen displays:

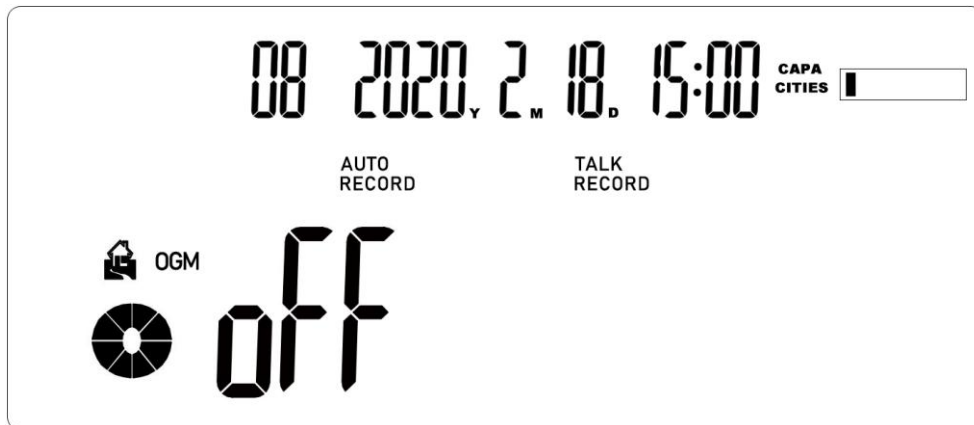

2. Press the Up/Down key to set, turn on/off the FSK incoming call automatic correction time
3. After the adjustment is completed, press the confirmation key to complete the setting

Chapter Third Playback of recorded files

1. Main screen, press the **Playback** button to enter the playback mode, then the screen displays:

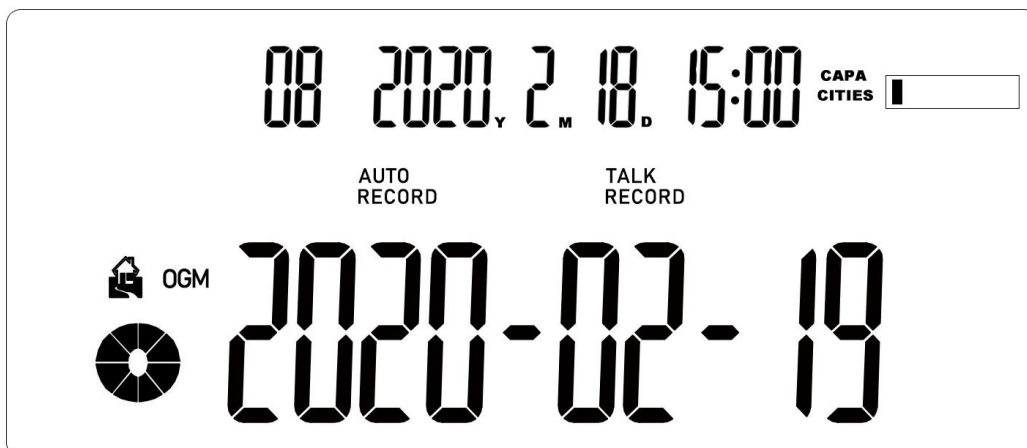

2. Press Up/Down/Left/Right key to select the date of the recording file, and press Enter to enter the playback mode

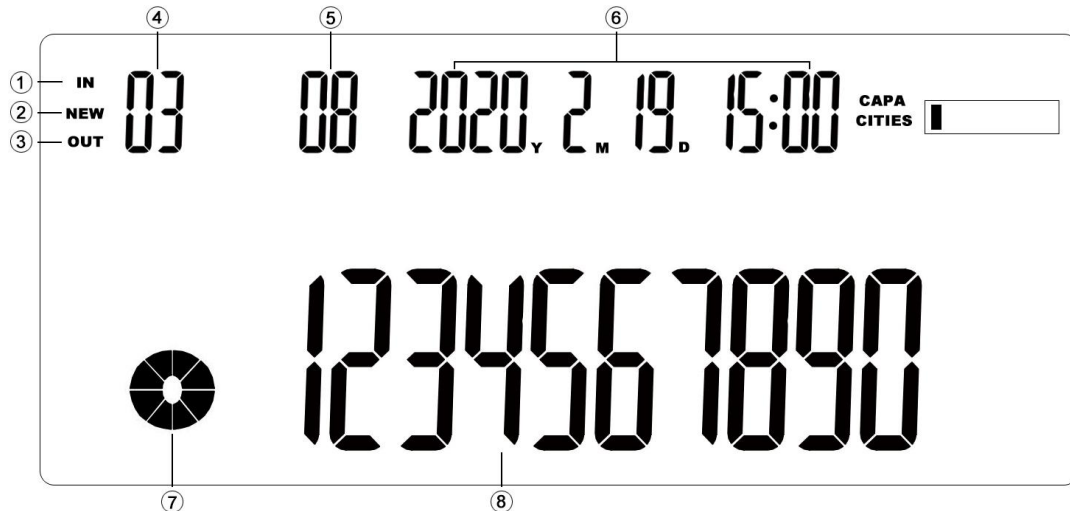

Number	Description	Note
1	Incoming call recording	During voice control recording, 1/2/3 Will not show
2	Message Recording	
3	Dial out to record	
4	Number of the current recording file	
5	Total number of recordings on the current date	Record up to 199 records in a day
6	Date of the current recording file	
7	Playback progress bar	
8	Phone number display area	No number displayed during voice-activated recording

3. When the recording file is being played back, pressing the delete key will delete the current recording file.

Chapter Four Upgrades and other considerations

1. Remove the SD card, and put the announced audio file in the SD card directory, as shown below:

此电脑 > U 盘 (G:) >

名称	修改日期	类型	大小
RecordFiles		文件夹	
Upgrade	2020-01-17 16:59	文件夹	
Setting		文件	1 KB
LeaveMessage	2020-01-15 12:21	媒体文件(.wav)	49 KB
Answer	2020-01-15 12:21	媒体文件(.wav)	43 KB

2. The format of the audio file is as follow: **Wave, A-Law, 8000Hz, 64kbps, mono**.
(It is recommended that use the free **GoldWave** software to generate)

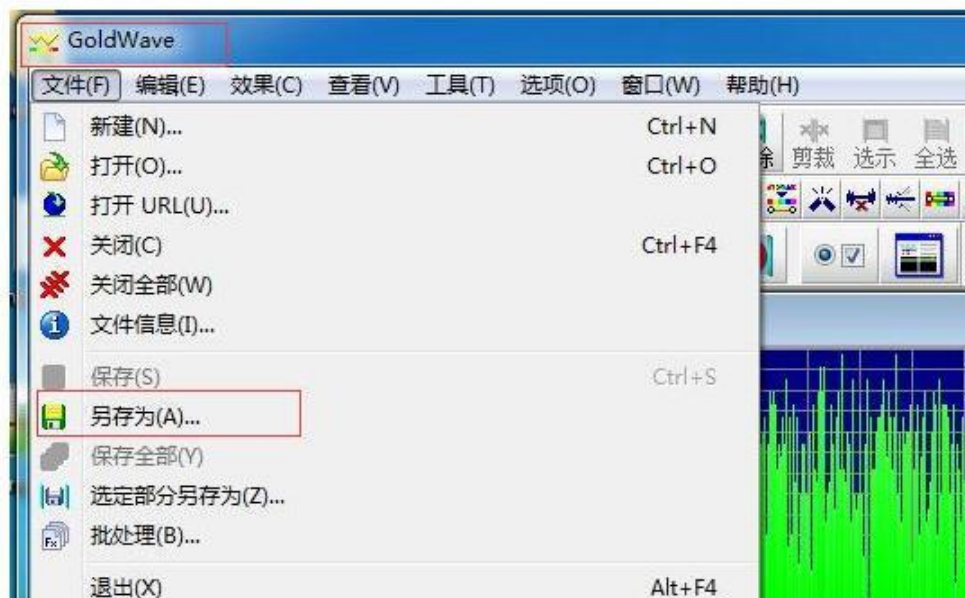
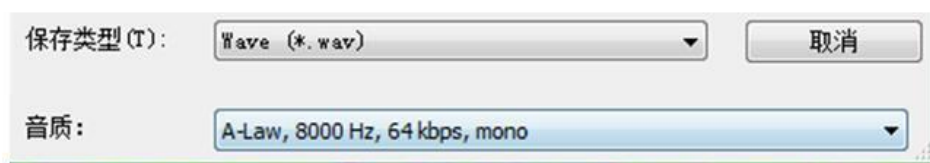

3. Answer: Incoming call announcement audio file name
 LeaveMessage: Message announcement audio file name for VoiceMail
 Note: If the above two file names and file formats are wrong, there will be no announcement function
4. Upgrade function: put the upgrade file in the Upgrade directory, then insert the SD card into the device, restart the device, wait for two minutes to complete the upgrade function
5. The device just supports the SD card in **FAT32 format**. If not, kindly reformat it to be FAT32 format via PC before use.
6. Kindly check the 6th page and notice the Default Value for every setting. **All the settings user made are stored in SD card with one file named "Setting", which is in the root directory of SD card.** Once user insert one new SD card without "Setting" file, the device will come back to factory mode. User just need copy the file "Setting" to one new SD card, then save time from making settings another time. But user can not mix the "Setting" files among 5001A, 5001B, 5001C and 5002C.

此电脑 > U 盘 (G:) >

名称	修改日期	类型	大小
RecordFiles		文件夹	
Upgrade	2020-01-17 16:59	文件夹	
Setting		文件	1 KB
LeaveMessage	2020-01-15 12:21	媒体文件(.wav)	49 KB
Answer	2020-01-15 12:21	媒体文件(.wav)	43 KB

7. It's "Series Connection" for DAR-5001A, then both the two RJ11 ports should be connected: **Left** for **PSTN**, and **Right** for **Phone**(as the below picture). *If it's mixed or user just "Parallel Connects" only one RJ11 port, the Call Announcement before Ringing can not be available.*

It's "Series Connection" for DAR-5001A, both the two RJ11 ports should be conncted: Left for PSTN, and Right for Phone.



PSTN(left port)

Phone(right port)



Chapter Five OGM/anti-harassment

1. When OGM is activated on the recording box, the outside line makes an incoming call. At this time, the extension on the recording box does not ring, and the recording box automatically answers.

2. The recording box recognizes the call CID information and plays the announcement content
3. After the announcement is complete, the recording box sends ringing and outside line CID information to the telephone extension
4. When the number of rings reaches the message setting condition (the recording box starts the message function), the recording box enters the message mode, and after the announcement of the message is played, a voice message can be made. If the recording box is not enabled with the message function or the message setting conditions are not met, the recording box will continue to ring the extension. When the number of rings reaches 9 times, the user does not answer, and the recording box returns to the standby state.